

DPC-193/392/393/395/ 692/792/793/993 SERVICE MANUAL

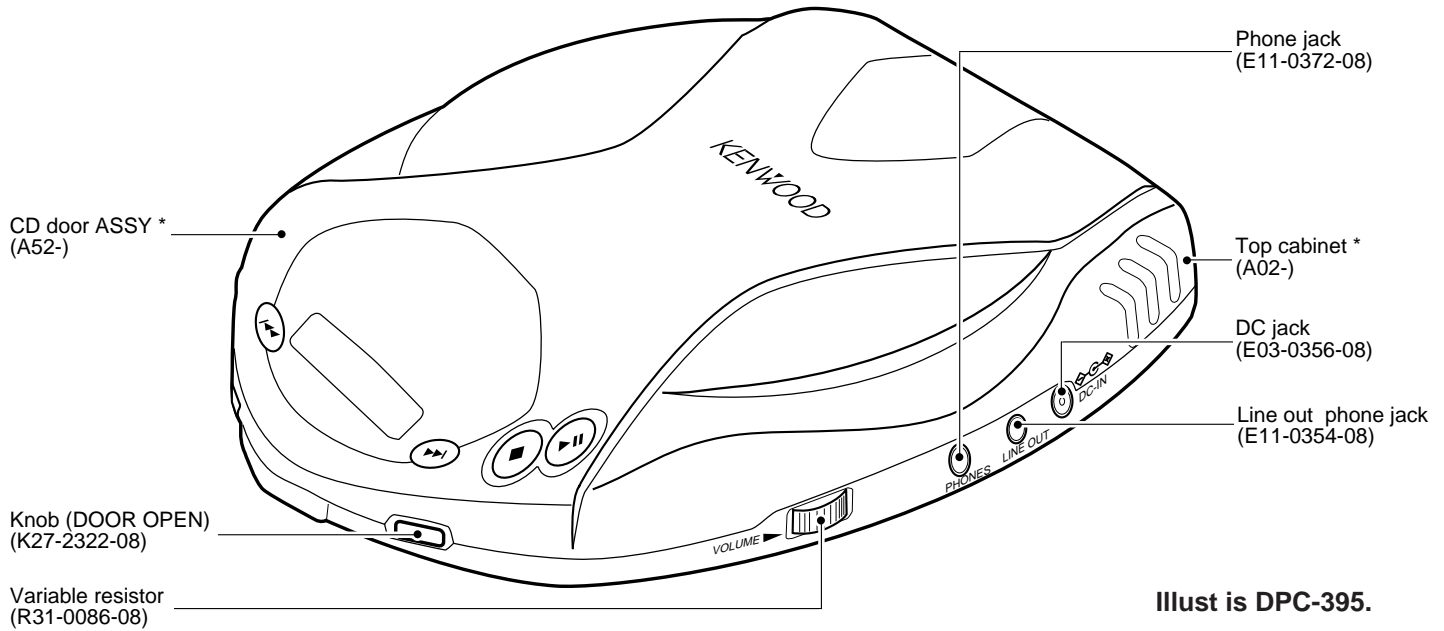

Illust is DPC-395.

* Refer to parts list on page 13.

SPECIFICATIONS

Format	
System	Compact disc digital audio system
Laser	Semiconductor laser
Audio	
Frequency response	20 Hz to 20 kHz, ±3 dB
PHONES output level (16Ω, 1 kHz)	10 mW + 10 mW
Line output/impedance	0.6 Vrms/1 kΩ
Power supply	
External DC supply	4.5V to 6 V DC
Rechargeable batteries (NB-88 or NB-130) x 2 or 4	DC 2.4 V
Commercially-available alkaline batteries (LR6/AA) x 2 or 4	DC 3 V
Battery life (continuous repeat playback)	
(Figures inside parentheses show the performance when the D.A.S.C. is ON.)	
Commercially-available alkaline batteries (LR6/AA) x 2	Approx. 12 (9.5) Hours
Commercially-available alkaline batteries (LR6/AA) x 4	Approx. 25 (20) Hours
Rechargeable batteries (NB-88) x 2	Approx. 5.5 (4.5) Hours
Alkaline batteries (LR6/AA) x 2 and rechargeable batteries (NB-88) x 2	Approx. 18 (15) Hours
Dimensions (W x H x D) (DPC-395/792/795)	132 mm x 32.5 mm x 153 mm (5 - 3/16" x 1 - 1/4" x 6")
Dimensions (W x H x D) (DPC-193/392/393/793)	132 mm x 29.5 mm x 153 mm (5 - 3/16" x 1 - 3/16" x 6")
Weight (net) (DPC-395/792/795)	272 g (9.6 oz)
Weight (net) (DPC-193/392/393/793)	260 g (9.2 oz)

In compliance with Federal Regulations, following are reproductions of labels on, or inside the product relating to laser product safety.

KENWOOD-Corp. certifies this equipment conforms to DHHS Regulations No. 21 CFR 1040. 10, Chapter 1, Subchapter J.

**DANGER : Laser radiation when open and interlock defeated.
AVOID DIRECT EXPOSURE TO BEAM.**

CONTENTS / ACCESSORIES

Contents

SPECIFICATIONS	Top cover	SCHMATIC DIAGRAM	7
CONTENTS / ACCESSORIES	2	EXPLODED VIEW	12
CIRCUIT DESCRIPTION	3	PARTS LIST	13
PC BOARD	5		

Model feature list

	1		2		3				4	5			6			7	9	
	DPC-193		DPC-392		DPC-393				DPC-395	DPC-692			DPC-792			DPC-793	DPC-993	
	M	X	M	E	M	M2	T	E	M	K	P	K	P	X	E	K	P	
	TACT	TACT	TACT	TACT	TACT	TACT	TACT	TACT	TACT	TACT	TACT	TACT	TACT	TACT	TACT	TACT	TACT	TACT
BASE BOOST SW	-	-	-	-	-	-	-	-	-	-	-	-	-	-	-	-	-	-
DASC<OFF-ON(4M)>IC7	-	-	YES	YES	YES	YES	YES	YES	YES	-	-	-	-	-	-	-	-	-
DASC<ST-OFF-HI(16M)>IC6	-	-	-	-	-	-	-	-	-	YES	YES	YES	YES	YES	YES	YES	YES	YES
DIGITAL OPT OUT(J104)	-	-	-	-	-	-	-	-	-	-	-	-	-	-	YES	-	-	-
LINE OUT(J105)	YES	YES	YES	YES	YES	YES	YES	YES	YES	YES	YES	YES	YES	YES	-	YES	YES	YES
REMOCON JACK(J103)	-	-	-	-	-	YES	-	-	YES	-	-	-	-	-	YES	-	-	-
CAR BATTERY ADP.	-	-	YES	YES	-	-	-	-	-	YES	YES	YES	YES	YES	-	-	-	-
CAR CASSETTE ADP.	-	-	YES	YES	-	-	-	-	-	YES	YES	YES	YES	YES	-	-	-	-
RECHARGEABLE BATT.	NB-88	NB-88	NB-88	-	NB-88	NB-88	NB-88	-	NB-88	-	-	-	-	NB-88	NB-88	-	-	-
INNER HEADPHONE(SHORT)	-	-	-	-	-	YES	-	-	YES	-	-	-	-	-	YES	-	-	-
INNER HEADPHONE(LONG)	YES	YES	YES	YES	YES	-	YES	YES	-	-	-	-	-	YES	-	-	-	-
OPEN HEADPHONE(LOW)	-	-	-	-	-	-	-	-	-	YES	YES	-	-	-	-	-	-	-
OPEN HEADPHONE(HI/LONG)	-	-	-	-	-	-	-	-	-	-	-	YES	YES	-	-	-	-	-
NOISE CANCEL HP(LONG)	-	-	-	-	-	-	-	-	-	-	-	-	-	-	-	-	-	YES
REMOCON WIRED	-	-	-	-	-	LCD	-	-	3KEY	-	-	-	-	-	3 KEY	-	-	-

Accessories

AC adapter(1)
 (W08-0657-08) : K5K6K9P5P9P6
 (W08-0658-08) : E2E7E3
 (W08-0659-08) : T3
 (W08-0660-08) : X6
 (W08-0675-05) : M2M3M4S3

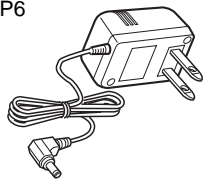

Innerphone.....(1)
 (W01-0925-05) : E2E3M1M2M3T3X1X6
 (W01-0923-05) : E7M4S3

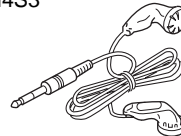

Rechargeable battery (NB-88)(1)
 (W09-1240-05) : E7M1M2M4M3S3T3X1X6

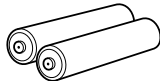

Remote control.....(1)
 (A70-1111-08) : E7M4

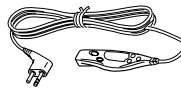

Remote control.....(1)
 (A70-1190-05) : S3

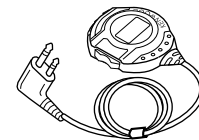

Headphone(1)
 (W01-0924-05) : K5P5
 (W01-0943-05) : K6P6
 (W01-0947-05) : K9P9

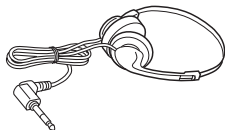

Car cassette adapter.....(1)
 (W01-0922-05) : E2K5K6M2P5P6X6

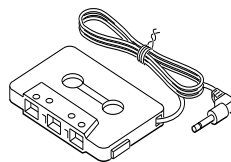

Car battery adapter(1)
 (W01-0921-05) : E2M2K5K6P5P6X6

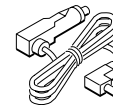

AC plug(1)
 (E03-0115-05) : M1M2M3M4S3

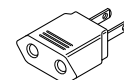

CIRCUIT DESCRIPTION

1. Microprocessor : MN101C167

1-1 Pin description

Pin No.	Name	I/O	Description	Remarks
1-4	COM1-4	O	LCD common signal	
5	VLC3	-	GND	
6,7	VLC1,2	-	LCD driving bias control	
8	VDD	-	Power supply(+2.8V)	
9	OSC2	-	No use	
10	SMCK	I	External system clock(4.2336MHz)	
11	VSS	-	GND	
12	X1	-	GND	
13	X0	-	No use	
14,15	MMOD,VREF	-	GND	
16	KEY1	I	Key input	
17	KEY2	I	Remocon key input port	
18	RECHARGE OUT	O	Rechargeable detection port	
19	BATT	-	No use	
20	HOLD	I	Key hold on/off control	ON=H
21	DOOR	I	Door switch detection port	OPEN=H
22	DA SCST	I/O	DASC switch detection port(ST)	
23	DA SCHI	I	DASC switch detection port(HI)	
24	VREF+	-	Power supply(+2.8V)	
25	P00	-	No use	
26	SUBQ	I	Sub-Q data input signal port(to MN662746RPK1)	
27	SQCK	I	Sub-Q data read timing clock port(to MN662746RPK1)	
28	MDATA	O	Data signal port(to MN662746RPK1)	
29	P04	-	No use	
30	MCLK	O	Clock signal port(to MN662746RPK1)	
31	P06	-	No use	
32	RESET	I	System reset port	
33-37	P10-14	-	No use	
38	BLKCK	I	Sub-Q signal read require port	
39	P21	-	No use	
40	REM IN	I	Remocon data input port	
41,42	P23,24	-	No use	
43	YMCLK	O	Clock signal port(to SM5859AF/5902AF)	
44	YMDATA	O	Audio signal port(to SM5859AF/5902AF)	
45	YMLD	O	Latch signal port(to SM5859AF/5902AF)	
46	YD MUTE	O	Audio signal mute control port	ON=H
47	ZSENSE	O	Sensitive signal port(to SM5859AF/5902AF)	
48	NRESET	O	System reset port(to SM5859AF/5902AF)	
49,50	P53,54	-	No use	
51	POWER	O	Power supply control port	
52	REM DATA	O	Remocon data output port	
53	CONT	O	DASC control output port(HI/ST)	ON=H
54	BBS	O	BBS control	ON=L
55	LMT	I	Limit switch detection port	
56	EMP	O	Battery level detection port	LOW BATT=H

CIRCUIT DESCRIPTION

Pin No.	Name	I/O	Description	Remarks
57-59	P66,67,70	-	No use	
60	RECHARGE	I	Rechargeable battery detection port	
61	LIGHT OUT	-	No use	
62	MLD	O	Latch signal port(to MN662746RPK1)	
63	SENSE	I	Sensitive signal port	
64	FLOCK	I	Focus servo	IN=L
65	TLOCK	I	Tracking servo	IN=L
66	STAT	I	Status signal port	
67	RST	O	Reset signal port(to MN662746RPK1)	
68-71	P83-86	-	No use	
72	DIGITAL OUT	O	Digital output control	
73	P81	I	Memory selector	NO=H,4M=H,16M=L
74	P80	I	Memory selector	NO=L,4M=H,16M=L
75-85	SEG15-25	-	LCD segment signal	
86-100	SEG0-14	O	LCD segment signal	

1-2 Microprocessor periphery block diagram

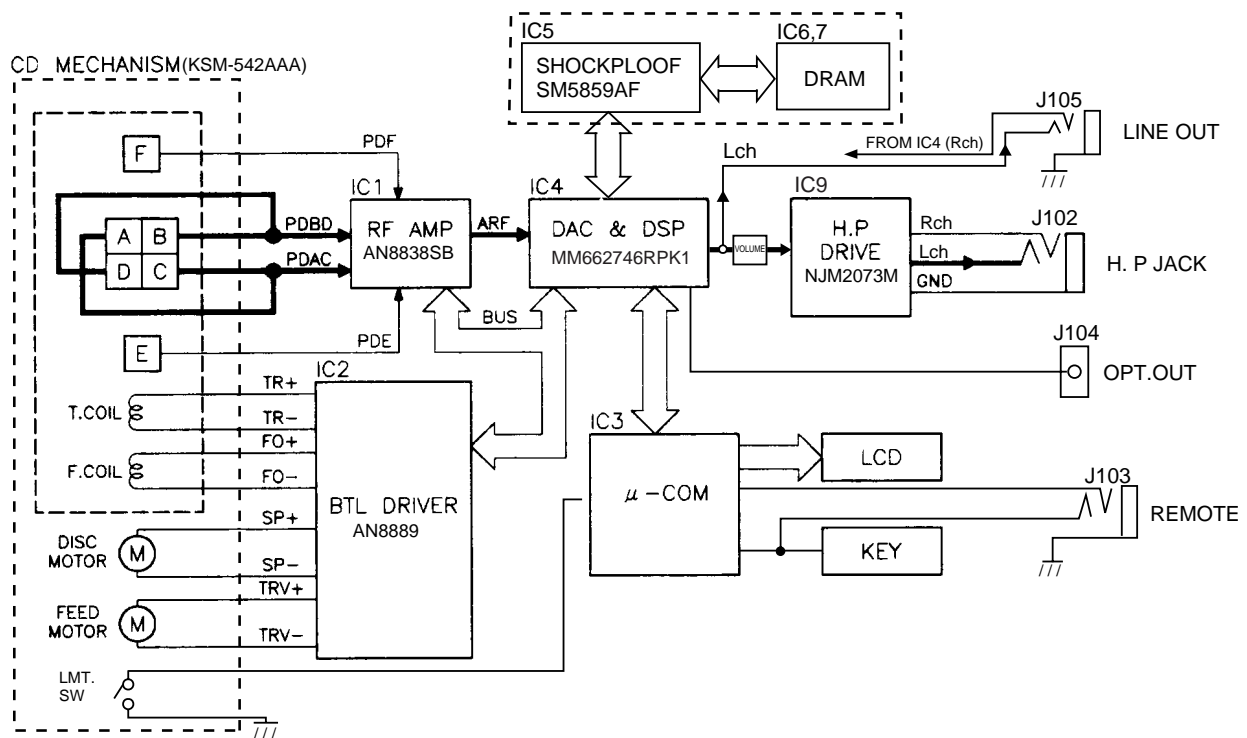

PC BOARD (Component side view)

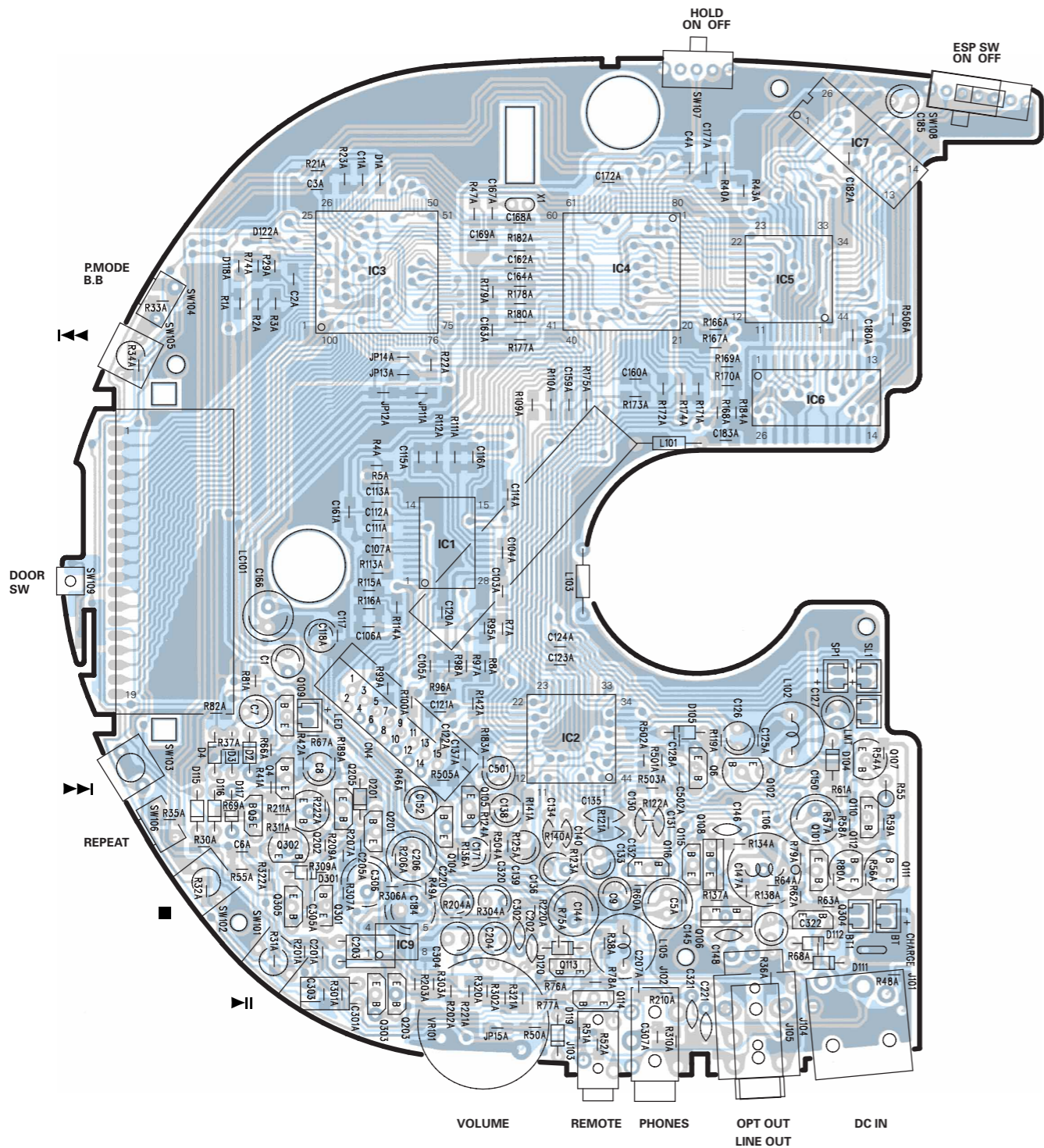

(Foil side view)

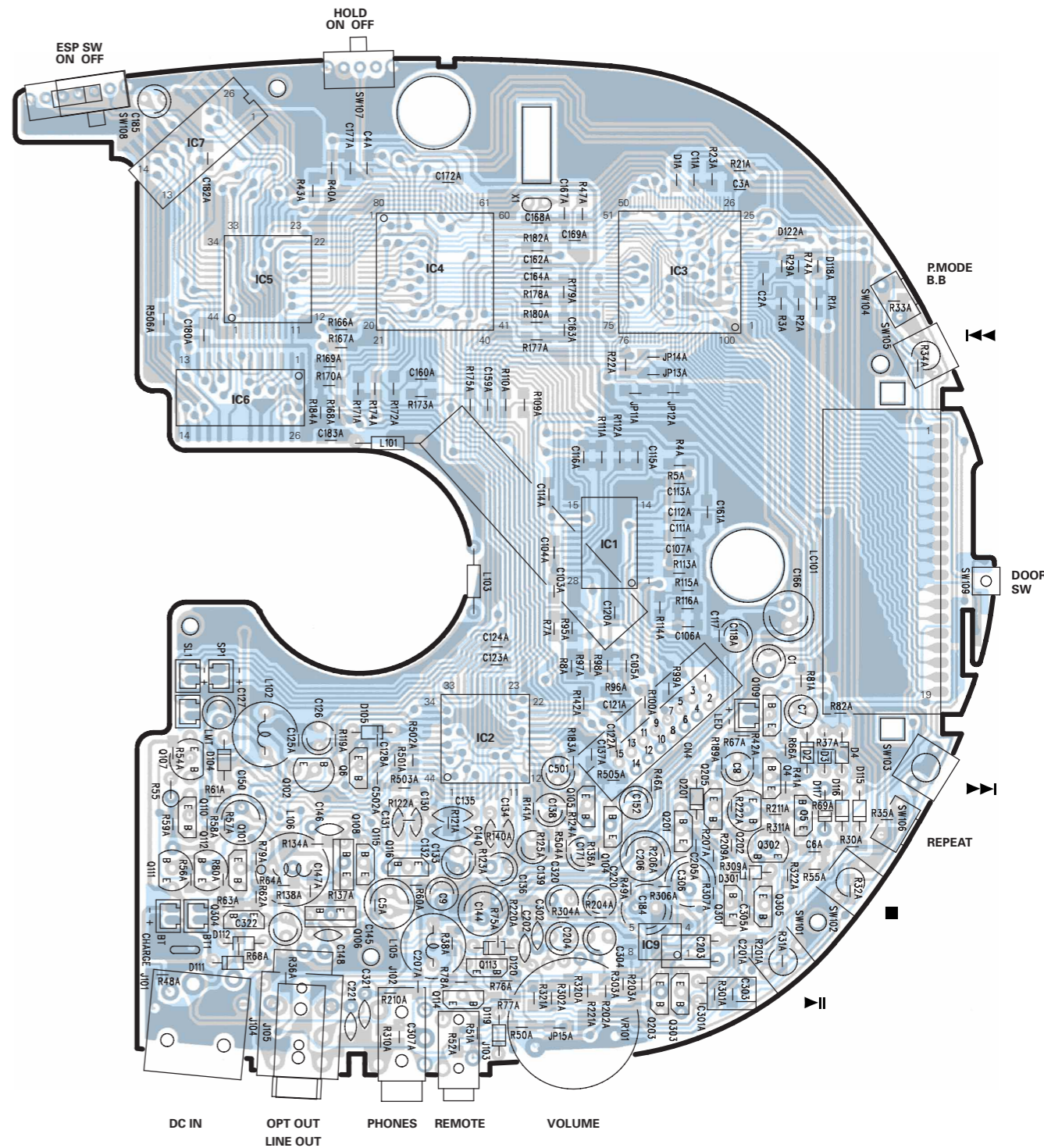

Refer to the schematic diagram for the value of resistors and capacitors.

MECHA. ASS'Y
(KSM-542A)

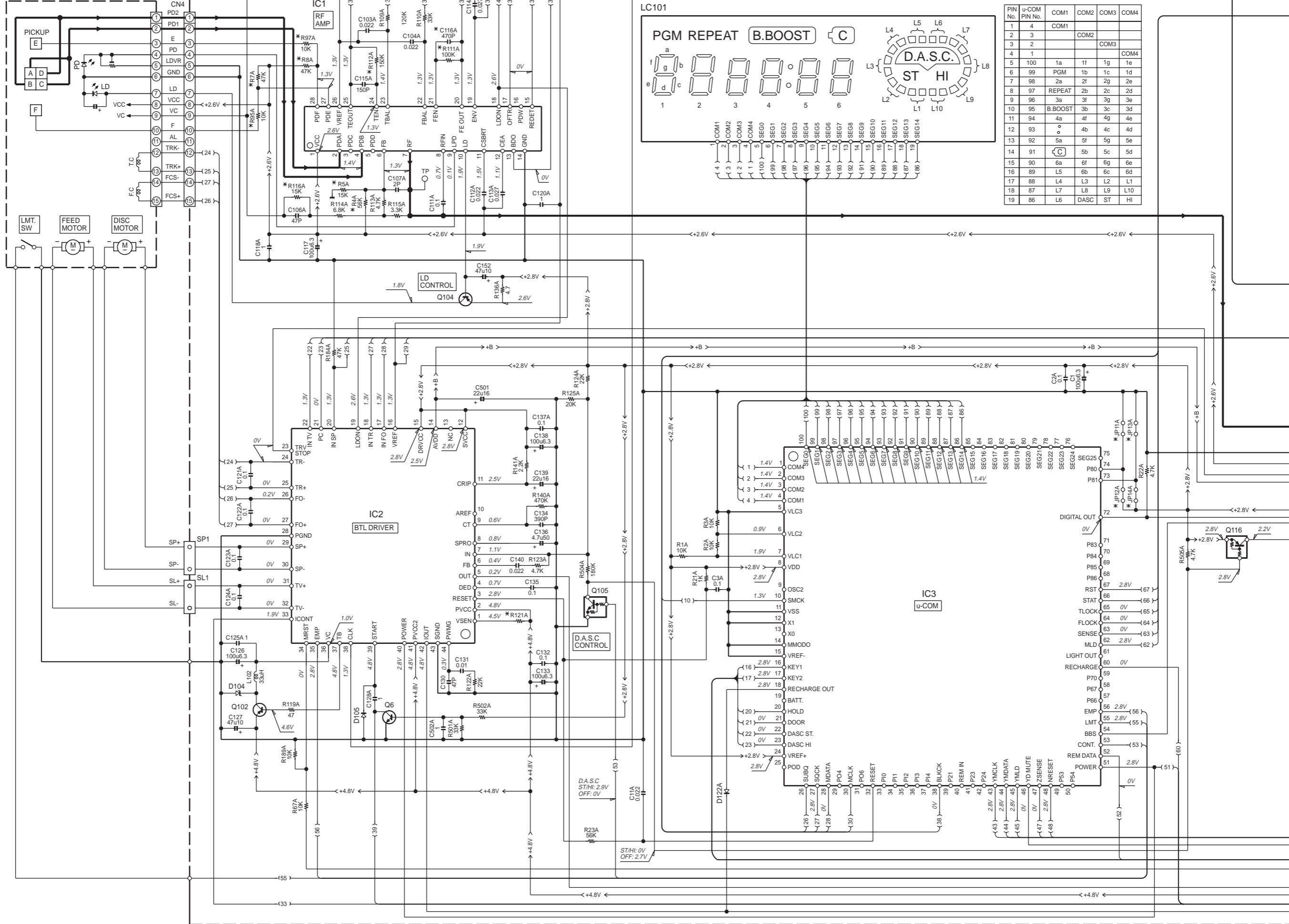

PIN No.	u-COM PIN No.	COM1	COM2	COM3	COM4
1	4	COM1			
2	3		COM2		
3	2			COM3	
4	1				COM4
5	100	1a	1f	1g	1e
6	99	PGM	1b	1c	1d
7	98	2a	2f	2g	2e
8	97	REPEAT	2b	2c	2d
9	96	3a	3f	3g	3e
10	95	B.BOOST	3b	3c	3d
11	94	4a	4f	4g	4e
12	93	5a	5f	5g	5e
13	92	6a	6f	6g	6e
14	91	7a	7f	7g	7e
15	90	8a	8f	8g	8e
16	89	L5	8b	8c	8d
17	88	L4	L3	L2	L1
18	87	L7	L8	L9	L10
19	86	L6	DASC	ST	HI

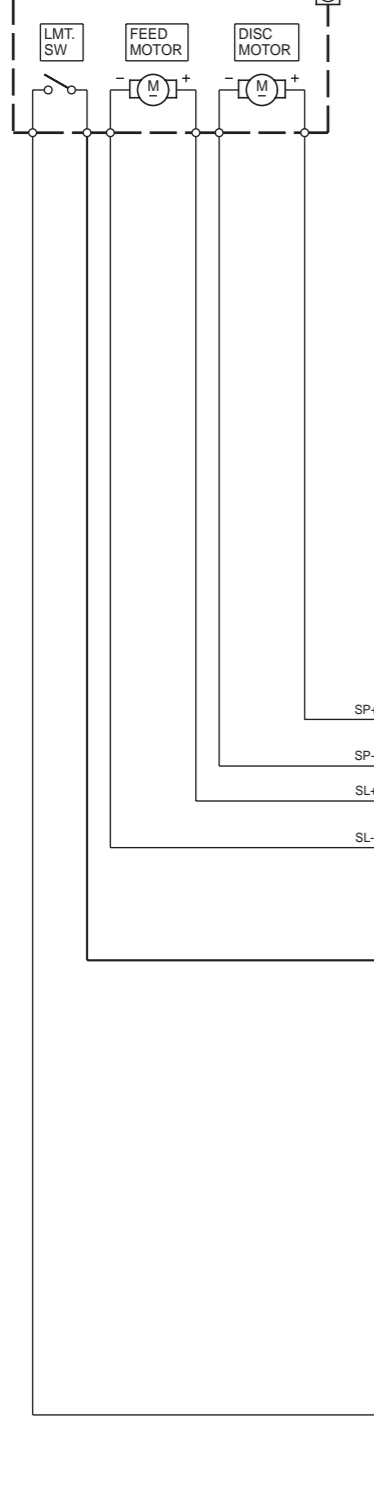
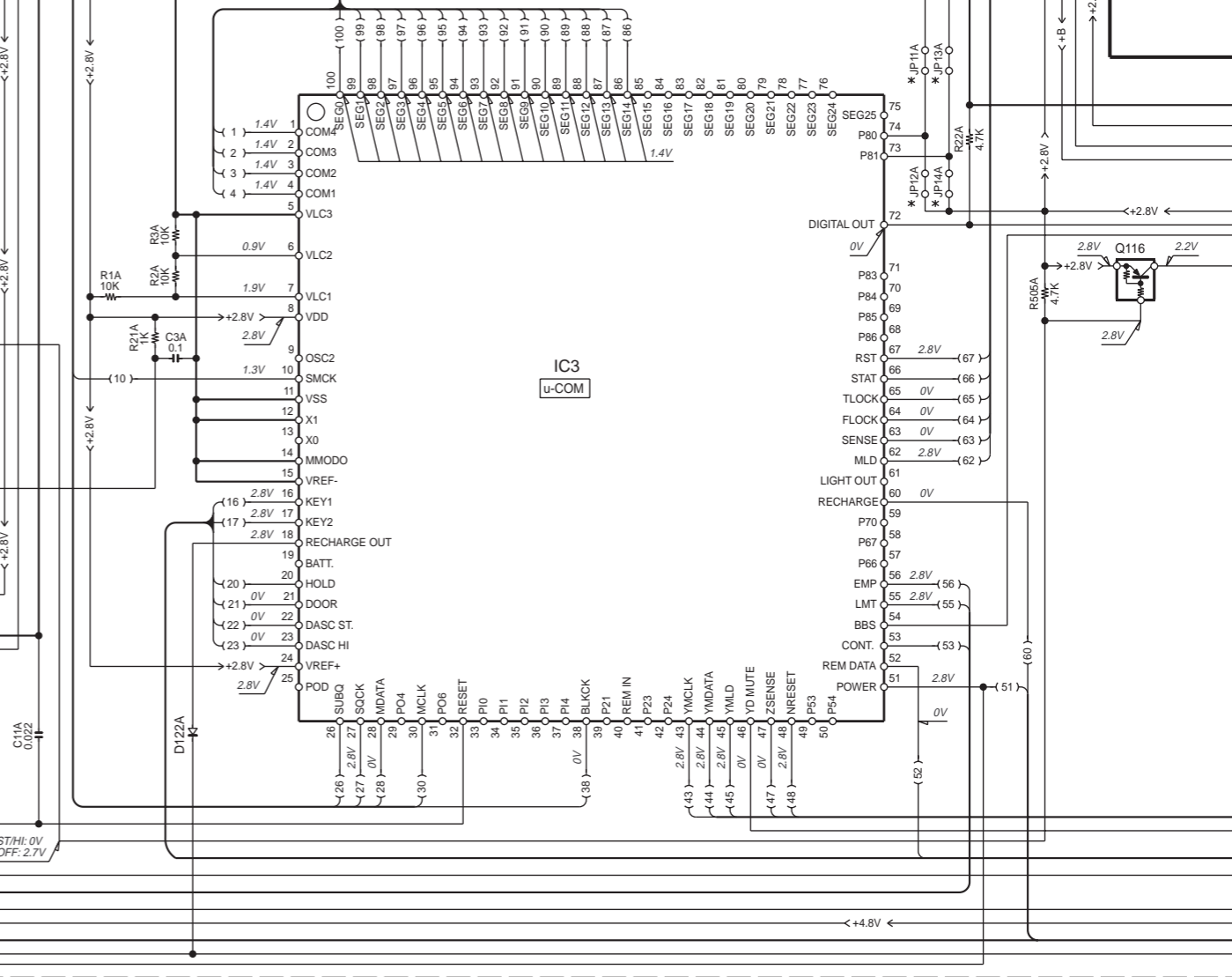
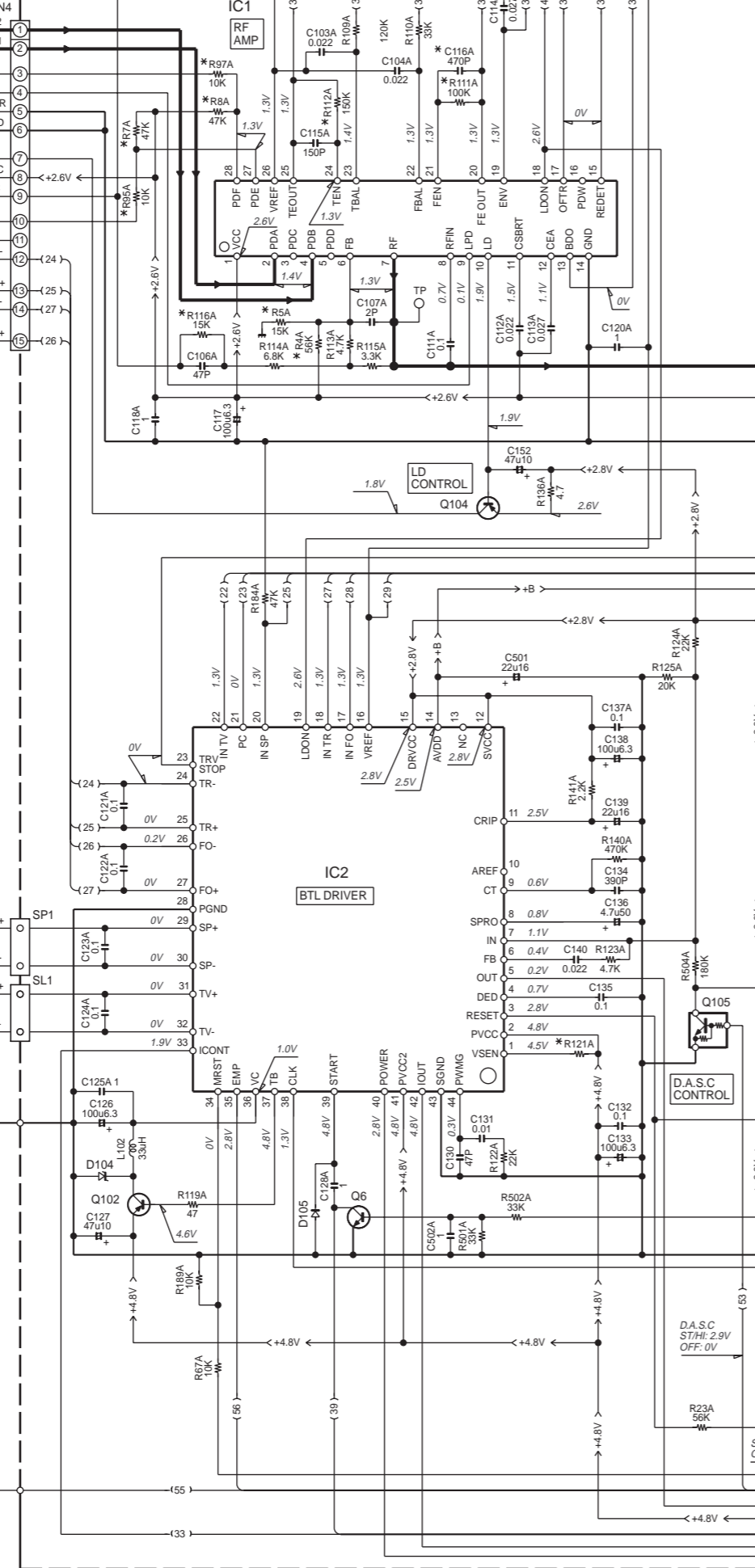
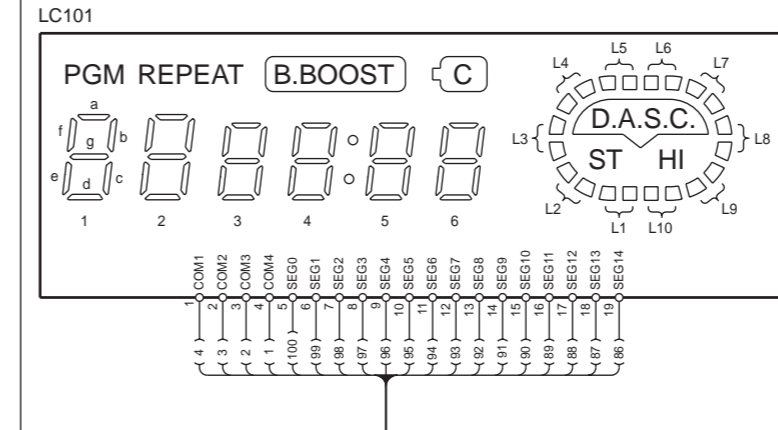

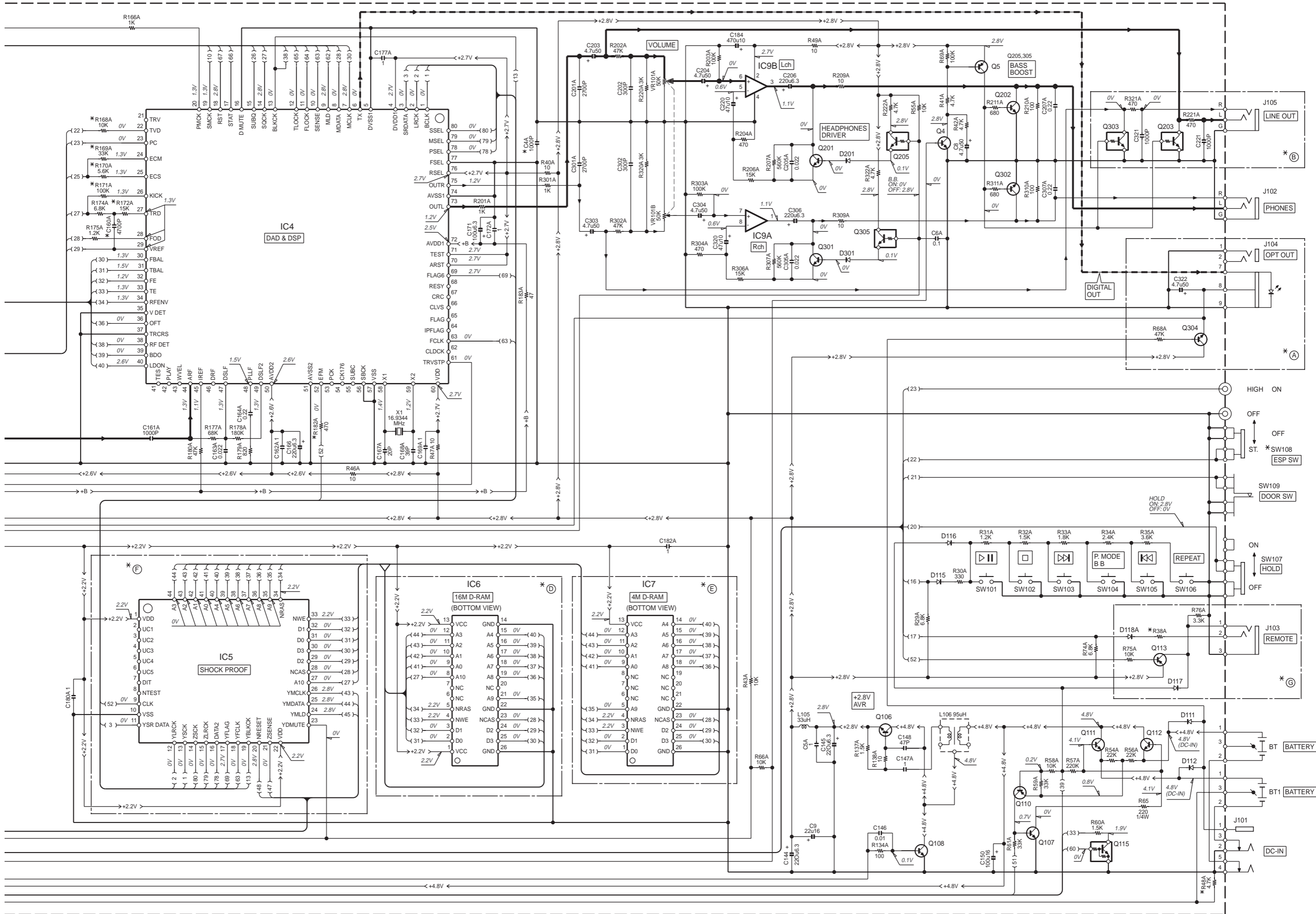

R166A
1K

IC4
DAD & DSP

VOLUME

IC9B [Lch]

HEADPHONES DRIVER

BASS BOOST

IC5
SHOCK PROOF

IC6
16M D-RAM
(BOTTOM VIEW)

IC7
4M D-RAM
(BOTTOM VIEW)

J105
LINE OUT

J102
PHONES

J104
OPT OUT

HIGH ON

OFF

OFF

ST. *SW108
ESP SW

SW109
DOOR SW

ON

SW107
HOLD

J103
REMOTE

BT BATTERY

BT1 BATTERY

DC-IN

J101

J101

DPC-993

DESTINATION	ABB.	A, C, E, G	B, D	F	C4A, 160A	C116A	R4A, 5A	R7A, 8A, 38A, 51A, 52A, 75A, 95A, 97A, 116A, 168A	R111A, 171A	R112A	R121A, 170A	R169A	R172A	R182A	JP11A, 13A	JP12A, 14A	SW108 (D.A.S.C.)	
COUNTRY	ABB.	OFF ◀ ON ▶ ST ◀ OFF ▶ HI																
U.S.A.	K9	NO	YES	NO	YES	1000P	YES	NO	47K	100K	2.2K	4.7K	15K	NO	YES	NO	NO	YES
CANADA	P9	NO	YES	NO	YES	1000P	YES	NO	47K	100K	2.2K	4.7K	15K	NO	YES	NO	NO	YES

DPC-793

DESTINATION	ABB.	A, C, E, G	B, D	F	C4A, 160A	C116A	R4A, 5A, 75A, 95A, 97A	R7A, 8A	R38A, 48A, 51A, 52A, 116A, 182A	R111A	R112A	R121A	R168A	R169A	R170A	R171A	R172A	JP11A, 13A	JP12A, 14A	SW108 (D.A.S.C.)		
COUNTRY	ABB.	OFF ◀ ON ▶ ST ◀ OFF ▶ HI																				
EUROPE	E7	YES	NO	YES	NO	NO	470P	NO	47K	YES	100K	150K	0/3.9K	10K	12K	5.6K	68K	0	YES	NO	NO	YES

DPC-792

DESTINATION	ABB.	A, C, E, G	B, D	F	C4A, 160A	C116A	R4A, 5A	R7A, 8A, 38A, 51A, 52A, 75A	R48A, 95A, 97A, 116A	R111A	R112A	R121A	R168A	R169A	R170A	R171A	R172A	R182A	JP11A, 13A	JP12A, 14A	SW108 (D.A.S.C.)		
COUNTRY	ABB.	OFF ◀ ON ▶ ST ◀ OFF ▶ HI																					
U.S.A.	K6	NO	YES	YES	NO	1000P	YES	NO	NO	47K	100K	2.2K	4.7K	12K	2.2K	47K	0	YES	YES	NO	NO	YES	
CANADA	P6	NO	YES	NO	YES	470P	YES	NO	YES	100K	150K	0/3.9K	10K	12K	2.2K	68K	15K	0	YES	YES	NO	NO	YES
AUSTRALIA	X6	NO	YES	NO	YES	470P	YES	NO	YES	100K	150K	0/3.9K	10K	12K	2.2K	68K	0	YES	YES	NO	NO	YES	

DPC-692

DESTINATION	ABB.	A, C, E, G	B, D	F	C4A, 160A	C116A	C160A	R4A, 5A, 95A, 97A	R7A, 8A	R38A, 48A, 51A, 52A, 75A, 116A	R111A	R112A	R121A	R168A	R169A	R170A	R171A	R172A	R182A	JP11A, 13A	JP12A, 14A	SW108 (D.A.S.C.)		
COUNTRY	ABB.	OFF ◀ ON ▶ ST ◀ OFF ▶ HI																						
U.S.A.	K5	NO	YES	YES	NO	1000P	YES	YES	NO	NO	100K	150K	2.2K	4.7K	12K	2.2K	68K	15K	0	YES	YES	NO	NO	YES
CANADA	P5	NO	YES	NO	YES	470P	NO	NO	YES	NO	100K	150K	2.2K	4.7K	12K	2.2K	68K	15K	0	YES	YES	NO	NO	YES

DPC-395

DESTINATION	ABB.	A, D	B, E	C	F, G	C4A, 116A, 160A	R4A	R5A, 7A, 8A, 48A, 75A, 95A, 97A, 116A	R38A	R51A, 52A	R111A, 171A	R112A	R121A, 170A	R168A	R169A	R172A	R182A	JP11A, 12A, 13A, 14A	SW108 (D.A.S.C.)	
COUNTRY	ABB.	OFF ◀ ON ▶ ST ◀ OFF ▶ HI																		
JAPAN	J	NO	YES	NO	YES	YES	YES	NO	100	NO	47K	100K	2.2K	4.7K	12K	0	YES	NO	YES	NO
GENERAL MARKET	M4	NO	YES	NO	YES	YES	YES	NO	NO	YES	47K	100K	2.2K	4.7K	12K	15K	NO	NO	YES	NO

DPC-393

DESTINATION	ABB.	A, D	B, E	C, F	G	C4A	C116A	C160A	R4A, 5A, 48A, 95A, 97A, 116A	R7A, 8A, 182A	R38A	R51A, 52A	R75A	R111A	R112A	R121A	R168A	R169A	R170A	R171A	R172A	JP11A, 12A, 13A, 14A	SW108 (D.A.S.C.)		
COUNTRY	ABB.	OFF ◀ ON ▶ ST ◀ OFF ▶ HI																							
JAPAN	J	NO	YES	YES	NO	NO	NO	NO	NO	YES	330	YES	NO	NO	100K	150K	3.9K	10K	12K	5.6K	68K	0	NO	YES	NO
EUROPE	E3	NO	YES	NO	NO	470P	NO	NO	NO	YES	NO	NO	NO	100K	150K	3.9K	10K	12K	5.6K	68K	NO	NO	YES	NO	
U.K.	T3	NO	YES	NO	NO	470P	NO	NO	NO	YES	NO	NO	NO	100K	150K	3.9K	10K	12K	5.6K	68K	NO	NO	YES	NO	
GENERAL MARKET	M3	NO	YES	NO	NO	470P	NO	NO	NO	YES	NO	NO	NO	100K	150K	3.9K	10K	12K	5.6K	68K	NO	NO	YES	NO	
GENERAL MARKET	S3	NO	YES	NO	NO	470P	NO	NO	NO	YES	NO	NO	NO	100K	150K	3.9K	10K	12K	5.6K	68K	NO	NO	YES	NO	

DPC-392

DESTINATION	ABB.	A, C, D, G	B, E	F	C4A	C116A	C160A	R4A, 5A, 38A, 48A, 51A, 52A, 75A, 116A	R7A, 8A, 95A, 97A	R111A	R112A	R121A	R168A	R169A	R170A	R171A	R172A	R182A	JP11A, 12A, 13A, 14A	SW108 (D.A.S.C.)		
COUNTRY	ABB.	OFF ◀ ON ▶ ST ◀ OFF ▶ HI																				
EUROPE	E2	NO	YES	YES	YES	470P	NO	NO	YES	100K	150K	3.9K	10K	12K	5.6K	68K	0	YES	NO	YES	NO	
GENERAL MARKET	M2	NO	YES	NO	YES	470P	NO	NO	NO	100K	150K	3.9K	10K	12K	5.6K	68K	15K	0	YES	NO	YES	NO

DPC-193

DESTINATION	ABB.	A, C, D, E, F, G	B	C4A	C116A	C160A	R4A, 5A, 38A, 48A, 51A, 52A, 75A, 116A	R7A, 8A	R95A, 97A	R111A	R112A	R121A	R168A	R169A	R170A	R171A	R172A	JP11A	JP12A, 13A, 14A	SW108 (D.A.S.C.)	
COUNTRY	ABB.	OFF ◀ ON ▶ ST ◀ OFF ▶ HI																			
GENERAL MARKET	M1	NO	YES	YES	470P	NO	NO	NO	YES	100K	150K	2.2K	10K	12K	2.2K	68K	15K	0	YES	NO	NO
AUSTRALIA	X1	NO	YES	YES	470P	NO	NO	NO	YES	100K	150K	2.2K	10K	12K	2.2K	68K	15K	0	YES	NO	NO

- IC1 : AN8838SB : Q4,6,201,301,304 : 2SC3330
- IC2 : AN8789FB : Q5,104,110,113 : 2SA1317
- IC3 : MN101C167 : Q102 : 2SB598F
- IC4 : MN662746RPK1 : Q105,115 : 2SC4048-AC
- IC5 : SM5859AF : Q106 : 2SC4481T
- IC6 : MN41V17400CTT6 : Q107,202,302 : 2SD734F
- IC7 : MN41V4400SJ-08 : Q108 : 2SD1805F
- IC9 : NJM2073M : Q111,112 : 2SB926T
- Q116 : 2SA1564-AC
- Q203,205,303,305 : 2SC3860

- D104 : SB10-03A3-BT
- D105,115-117,201,301 : GMB01-BT
- D111,112 : 1N4001
- D118,122A : 1SS355

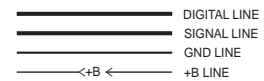

NJM2073M

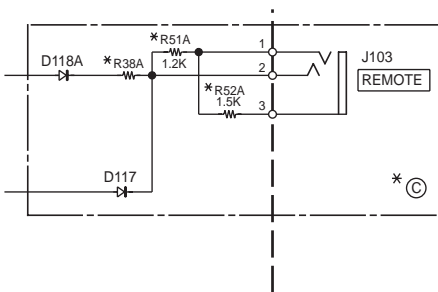
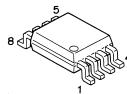

CAUTION: For continued safety, replace safety critical components only with manufacturer's recommended parts (refer to parts list). Δ indicates safety critical components. For continued protection against risk of fire, replace only with same type and rating fuse(s). To reduce the risk of electric shock, leakage-current or resistance measurements shall be carried out (exposed parts are acceptably insulated from the supply circuit) before the appliance is returned to the customer.

The DC voltage is an actual reading measured with a high impedance type voltmeter. The measurement value may vary depending on the measuring instruments used or on the product. Refer to the voltage during PLAY with DASC OFF(at the normal speed) unless otherwise specified; The value shown in () is the voltage measured at the moment of STOP.

DPC-193/DPC-393/DPC-793/
DPC-392/DPC-692/DPC-993/
DPC-792/DPC-395/DPC-795

DPC-193/392/393/395/692/792/793/993

Y22-7800-10

KENWOOD

EXPLODED VIEW(UNIT)

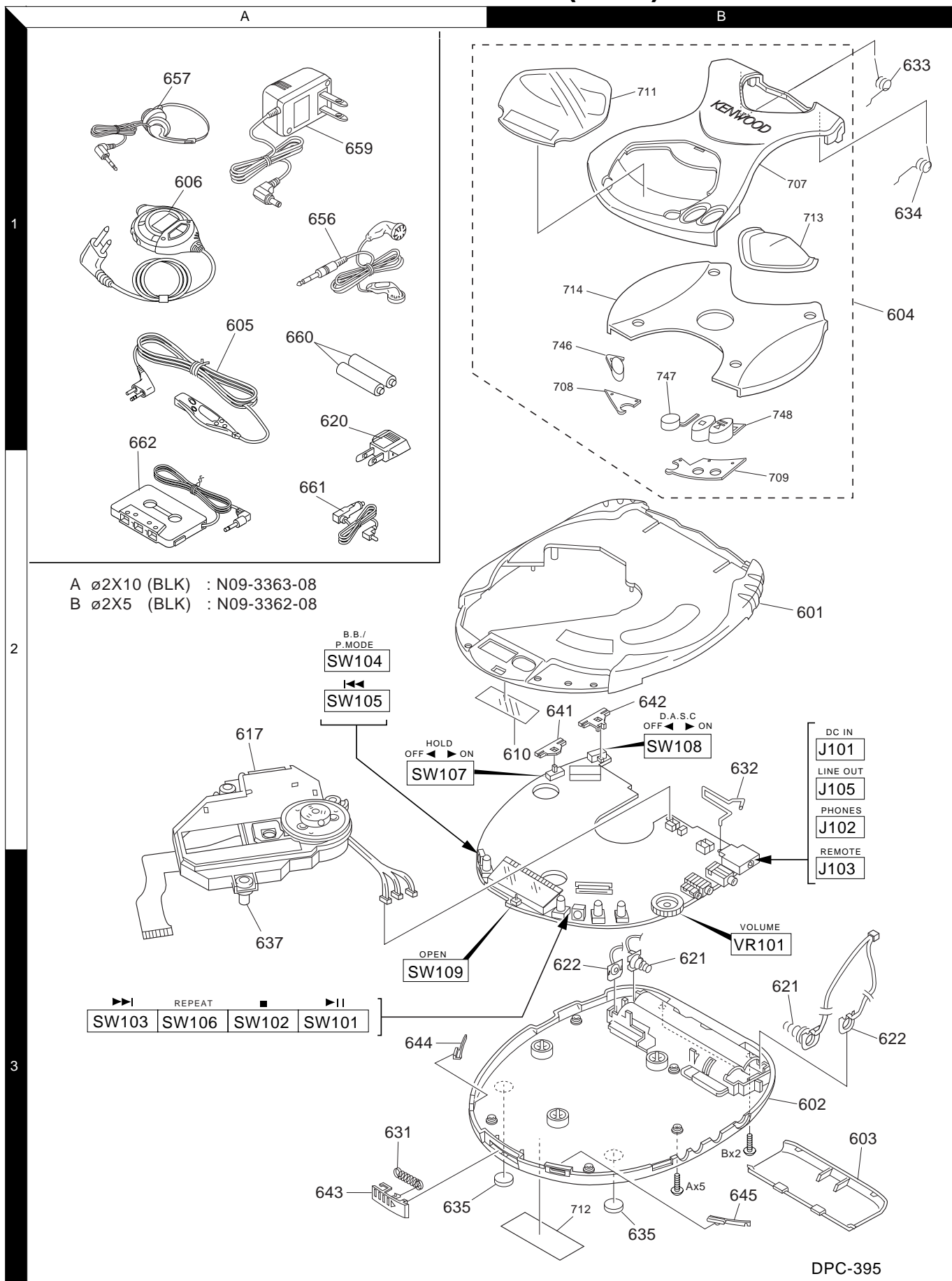

* New Parts

Parts without **Parts No.** are not supplied.

Les articles non mentionnés dans le **Parts No.** ne sont pas fournis.

Teile ohne **Parts No.** werden nicht geliefert.

①

Ref. No	Add-ress	New Parts	Parts No.	Description	Desti-nation	Re-marks
DPC-UNIT						
601	2B	*	A02-2872-08	TOP CABINET	M2	
601	2B	*	A02-2872-08	TOP CABINET	M3S3E2	
601	2B	*	A02-2872-08	TOP CABINET	M4E3T3	
601	2B	*	A02-2841-08	TOP CABINET	K6P6X6	
601	2B	*	A02-2841-08	TOP CABINET	K9P9E7	
601	2B	*	A02-2841-08	TOP CABINET	K5P5	
601	2B	*	A02-2874-08	TOP CABINET	M1X1	
602	3B	*	A02-2840-08	BOTTOM CABINET	M4S3	
602	3B	*	A02-2842-08	BOTTOM CABINET	K5P5	
602	3B	*	A02-2842-08	BOTTOM CABINET	K6P6X6	
602	3B	*	A02-2842-08	BOTTOM CABINET	K9P9E7	
602	3B	*	A02-2875-08	BOTTOM CABINET	M1X1	
602	3B	*	A02-2876-08	BOTTOM CABINET	E2M2	
602	3B	*	A02-2876-08	BOTTOM CABINET	E3T3M3	
603	3B	*	A09-1110-08	BATTERY DOOR	M2M1X1	
603	3B	*	A09-1110-08	BATTERY DOOR	M3S3E2	
603	3B	*	A09-1110-08	BATTERY DOOR	M4E3T3	
603	3B	*	A09-1111-08	BATTERY DOOR	K5P5	
603	3B	*	A09-1111-08	BATTERY DOOR	K6P6X6	
603	3B	*	A09-1111-08	BATTERY DOOR	K9P9E7	
604	1B	*	A52-0354-08	CD DOOR ASSY	M1X1	
604	1B	*	A52-0355-08	CD DOOR ASSY	E3T3M3	
604	1B	*	A52-0355-08	CD DOOR ASSY	S3	
604	1B	*	A52-0356-08	CD DOOR ASSY	E2M2	
604	1B	*	A52-0357-08	CD DOOR ASSY	E7	
604	1B	*	A52-0358-08	CD DOOR ASSY	K5P5	
604	1B	*	A52-0359-08	CD DOOR ASSY	K6P6X6	
604	1B	*	A52-0360-08	CD DOOR ASSY	K9P9	
604	1B	*	A52-0361-08	CD DOOR ASSY	M4	
605	1A	*	A70-1111-08	REMOTE CONTROL	E7M4	
606	1A	*	A70-1190-05	REMOTE CONTROL	S3	
610	2B	*	B10-3454-08	INNER DISPLAY LENS	K9P9K6	
610	2B	*	B10-3454-08	INNER DISPLAY LENS	M1X1	
610	2B	*	B10-3454-08	INNER DISPLAY LENS	P6X6E3	
610	2B	*	B10-3454-08	INNER DISPLAY LENS	T3M3S3	
-			B46-0100-50	WARRANTY CARD	E7X6E3	
-			B46-0100-50	WARRANTY CARD	T3E2X1	
-			B46-0322-03	WARRANTY CARD	K5	
-			B46-0328-03	WARRANTY CARD	K9K6	
-			B46-0336-03	WARRANTY CARD	P9P6P5	
-		*	B60-3946-08	INST MANUAL(EN)	K5P5	
-		*	B60-3946-08	INST MANUAL(EN)	K6P6	
-		*	B60-3946-08	INST MANUAL(EN)	K9P9	
-		*	B60-3947-08	INST MANUAL(FR)	P5E3E2	
-		*	B60-3947-08	INST MANUAL(FR)	P9E7P6	
-		*	B60-3948-08	INST MANUAL(EN)	M1X1	
-		*	B60-3948-08	INST MANUAL(EN)	M3S3M2	
-		*	B60-3948-08	INST MANUAL(EN)	X6M4T3	
-		*	B60-3949-08	INST MANUAL(SP)	E2M2M1	
-		*	B60-3949-08	INST MANUAL(SP)	E7E3M3	
-		*	B60-3949-08	INST MANUAL(SP)	M4	
-		*	B60-3950-08	INST MANUAL(TA)	M2M1	

L: Scandinavia K: USA P: Canada R: Mexico C: China I: Malaysia

Y: PX(Far East, Hawaii) T: Europe E: Europe G: Germany V: China(Shanghai)

Y: AAFES(Europe) X: Australia Q: Russia H: Korea M: Other Areas

▲ indicates safety critical components.

* New Parts

Parts without **Parts No.** are not supplied.

Les articles non mentionnés dans le **Parts No.** ne sont pas fournis.

Teile ohne **Parts No.** werden nicht geliefert.

②

Ref. No	Add-ress	New Parts	Parts No.	Description	Desti-nation	Re-marks
-		*	B60-3950-08	INST MANUAL(TA)	M4M3S3	
-		*	B60-3951-08	INST MANUAL(CH)	S3	
-		*	B60-3952-08	INST MANUAL(HO)	E7E3E2	
-		*	B60-3953-08	INST MANUAL(IT)	E7E3E2	
-		*	B60-3954-08	INST MANUAL(GR)	E7E3E2	
-			155-0000-2266	CAUTION SHEET	X6	
-			155-01911-0266	CAUTION SHEET(HOLD)	E7M4S3	
617	2A		D40-1547-08	CD MECHANISM KSM-542AAA		
▲ 620	1A		E03-0115-05	AC PLAG ADAPTER	M2M1	
▲ 620	1A		E03-0115-05	AC PLAG ADAPTER	M4M3S3	
621	3B		E23-1757-08	BATTERY CONTACT PLATE(-)		
622	3B		E23-1758-08	BATTERY CONTACT PLATE(+)		
631	3A	*	G01-4075-08	OPEN KNOB SPRING(FOR HOOK)		
632	2B	*	G01-4097-08	RECHARGE CONTACT SPRING		
633	1B	*	G01-4077-08	CD DOOR SPRING (L)	K5P5M4	
633	1B	*	G01-4077-08	CD DOOR SPRING (L)	K6P6X6	
633	1B	*	G01-4098-08	CD DOOR SPRING (L)	E3T3M3	
633	1B	*	G01-4098-08	CD DOOR SPRING (L)	K9P9E7	
633	1B	*	G01-4098-08	CD DOOR SPRING (L)	M1X1	
633	1B	*	G01-4098-08	CD DOOR SPRING (L)	S3E2M2	
634	1B	*	G01-4076-08	CD DOOR SPRING (R)	K5P5M4	
634	1B	*	G01-4076-08	CD DOOR SPRING (R)	K6P6X6	
634	1B	*	G01-4099-08	CD DOOR SPRING (R)	E3T3M3	
634	1B	*	G01-4099-08	CD DOOR SPRING (R)	K9P9E7	
634	1B	*	G01-4099-08	CD DOOR SPRING (R)	M1X1	
634	1B	*	G01-4099-08	CD DOOR SPRING (R)	S3E2M2	
635	3A, 3B	*	G13-0562-08	RUBBER FOOT		
-			H25-1603-08	EPE FOAM BAG		
-		*	H50-3036-08	ITEM CARTON CASE	X6	
-		*	H50-3038-08	ITEM CARTON CASE	M1	
-		*	H50-3039-08	ITEM CARTON CASE	X1	
-		*	H50-3041-08	ITEM CARTON CASE	M3	
-		*	H50-3042-08	ITEM CARTON CASE	S3	
-		*	H50-3043-08	ITEM CARTON CASE	T3	
-		*	H50-3044-08	ITEM CARTON CASE	E3	
-		*	H50-3045-08	ITEM CARTON CASE	M2	
-		*	H50-3047-08	ITEM CARTON CASE	E2	
-		*	H50-3050-08	ITEM CARTON CASE	E7	
-		*	H50-3051-08	ITEM CARTON CASE	K9P9	
-		*	H50-3053-08	ITEM CARTON CASE	M4	
-		*	H50-3056-08	ITEM CARTON CASE	K5P5	
-		*	H50-3057-08	ITEM CARTON CASE	K6P6	
637	3A		J02-1185-08	CUSHION(MECHA)		
641	2B	*	K27-2320-08	KNOB SIDE A		
642	2B	*	K27-2321-08	KNOB SIDE B		
643	3A	*	K27-2322-08	KNOB DOOR OPEN		
644	3A	*	K27-2326-08	KNOB CD BUTTON D	K9P9K6	
644	3A	*	K27-2326-08	KNOB CD BUTTON D	P5M4	
644	3A	*	K27-2326-08	KNOB CD BUTTON D	P6X6K5	
644	3A	*	K27-2341-08	KNOB CD BUTTON D	E7E3T3	
644	3A	*	K27-2341-08	KNOB CD BUTTON D	M2M1X1	
644	3A	*	K27-2341-08	KNOB CD BUTTON D	M3S3E2	
645	3B	*	K27-2327-08	KNOB CD BUTTON E	K9P9K6	

L: Scandinavia K: USA P: Canada R: Mexico C: China I: Malaysia

Y: PX(Far East, Hawaii) T: Europe E: Europe G: Germany V: China(Shanghai)

Y: AAFES(Europe) X: Australia Q: Russia H: Korea M: Other Areas

▲ indicates safety critical components.

PARTS LIST

DPC-193/392/393/395/692/792/793/993

* New Parts

Parts without **Parts No.** are not supplied.

Les articles non mentionnés dans le **Parts No.** ne sont pas fournis.

Teile ohne **Parts No.** werden nicht geliefert.

3

Ref. No	Add-ress	New Parts	Parts No.	Description	Desti-nation	Re-marks
645	3B	*	K27-2327-08	KNOB CD BUTTON E	P5M4	
645	3B	*	K27-2327-08	KNOB CD BUTTON E	P6X6K5	
645	3B	*	K27-2338-08	KNOB CD BUTTON E	E7E3T3	
645	3B	*	K27-2338-08	KNOB CD BUTTON E	M2M1X1	
645	3B	*	K27-2338-08	KNOB CD BUTTON E	M3S3E2	
A			N09-3363-08	SCREW 2X10 BLACK	144-62010-112	
B			N09-3362-08	SCREW 2X5 BLACK		
656	1A		W01-0923-05	INNER H/P(SHORT)	E7M4S3	
656	1A		W01-0925-05	INNER H/P(LONG)	E2M3M3	
656	1A		W01-0925-05	INNER H/P(LONG)	M1X1	
656	1A		W01-0925-05	INNER H/P(LONG)	X6E3T3	
657	1A		W01-0924-05	HEADPHONE	K5P5	
657	1A		W01-0943-05	HEADPHONE	K6P6	
657	1A		W01-0947-05	HEADPHONE	K9P9	
Δ 659	1A		W08-0657-08	AC-DC ADAPTOR	K9P9K6	
Δ 659	1A		W08-0657-08	AC-DC ADAPTOR	P6K5P5	
Δ 659	1A		W08-0658-08	AC-DC ADAPTOR	E7E3E2	
Δ 659	1A		W08-0659-08	AC-DC ADAPTOR	T3	
Δ 659	1A		W08-0660-08	AC-DC ADAPTOR	X6	
Δ 659	1A		W08-0675-08	AC-DC ADAPTOR	M4M3M2	
Δ 659	1A		W08-0675-08	AC-DC ADAPTOR	S3	
Δ 660	1A		W09-1240-05	RECHARGEABLE BATTERY	E7X6M4	
Δ 660	1A		W09-1240-05	RECHARGEABLE BATTERY	M2M1X1	
Δ 660	1A		W09-1240-05	RECHARGEABLE BATTERY	T3M3S3	
Δ 661	2A		W01-0921-05	CAR BATTERY ADAPTER	E2M2	
Δ 661	2A		W01-0921-05	CAR BATTERY ADAPTER	K5P5	
Δ 661	2A		W01-0921-05	CAR BATTERY ADAPTER	K6P6X6	
662	1A		W01-0922-05	CAR CASSETTE ADAPTER	K5P5E2	
662	1A		W01-0922-05	CAR CASSETTE ADAPTER	K6P6X6	
662	1A		W01-0922-05	CAR CASSETTE ADAPTER	M2	

ELECTRONICS PARTS

Ref. No	Add-ress	New Parts	Parts No.	Description	Desti-nation	Re-marks
LC101		*	B38-0171-08	LCD DISPLAY		
C1			CE04CW0J101M	ELECTRO	100UF	6.3WV
C2A, 3A			CK73FB1E104K	CHIP C	0.10UF	K
C4A			CK73FB1H102K	CHIP C	1000PF	K
C4A			CK73FB1H102K	CHIP C	1000PF	K
C4A			CK73FB1H102K	CHIP C	1000PF	K
C4A			CK73FB1H102K	CHIP C	1000PF	K
C4A			CK73FB1H102K	CHIP C	1000PF	K
C4A			CK73FB1H102K	CHIP C	1000PF	K
C5A			CK73FB1H105Z	CHIP C	1.0UF	Z
C6A			CK73FB1E104K	CHIP C	0.10UF	K
C8			CE04CW1H4R7M	ELECTRO	4.7UF	50WV
C9			CE04CW1C220M	ELECTRO	22UF	16WV
C11A			CK73FB1E223K	CHIP C	0.022UF	K
C103A, 104A			CK73FB1E223K	CHIP C	0.022UF	K
C106A			CC73FSL1H470J	CHIP C	47PF	J
C107A			CC73FSL1H020C	CHIP C	2.0PF	C
C111A			CK73FB1E104K	CHIP C	0.10UF	K
C112A			CK73FB1E223K	CHIP C	0.022UF	K
C113A, 114A			CK73FB1E273K	CHIP C	0.027UF	K
C115A			CC73FSL1H151J	CHIP C	150PF	J

* New Parts

Parts without **Parts No.** are not supplied.

Les articles non mentionnés dans le **Parts No.** ne sont pas fournis.

Teile ohne **Parts No.** werden nicht geliefert.

4

Ref. No	Add-ress	New Parts	Parts No.	Description	Desti-nation	Re-marks
C116A			CK73FB1H102K	CHIP C	1000PF	K
C116A			CK73FB1H102K	CHIP C	1000PF	K
C116A			CK73FB1H471K	CHIP C	470PF	K
C116A			CK73FB1H471K	CHIP C	470PF	K
C116A			CK73FB1H471K	CHIP C	470PF	K
C116A			CK73FB1H471K	CHIP C	470PF	K
C116A			CK73FB1H471K	CHIP C	470PF	K
C117			CE04CW0J101M	ELECTRO	100UF	6.3WV
C118A			CK73FB1H105Z	CHIP C	1.0UF	Z
C120A			CK73FB1H105Z	CHIP C	1.0UF	Z
C121A-124A			CK73FB1E104K	CHIP C	0.10UF	K
C125A			CK73FB1H105Z	CHIP C	1.0UF	Z
C126			CE04CW0J101M	ELECTRO	100UF	6.3WV
C127			CE04CW1A470M	ELECTRO	47UF	10WV
C128A			CK73FB1H105Z	CHIP C	1.0UF	Z
C130			CC45FSL1H470J	CERAMIC	47PF	J
C131			CK45FB1H103Z	CERAMIC	0.010UF	Z
C132			CK45FB1C104K	CERAMIC	0.10UF	K
C133			CE04CW0J101M	ELECTRO	100UF	6.3WV
C134			CC45FSL1H391J	CERAMIC	390PF	J
C135			CK45FB1C104K	CERAMIC	0.10UF	K
C136			CE04CW1H4R7M	ELECTRO	4.7UF	50WV
C137A			CK73FB1E104K	CHIP C	0.10UF	K
C138			CE04CW0J101M	ELECTRO	100UF	6.3WV
C139			CE04CW1C220M	ELECTRO	22UF	16WV
C140			CK45FB1H223M	CERAMIC	0.022UF	Z
C144, 145			CE04CW0J221M	ELECTRO	220UF	6.3WV
C146			CK45FB1H103Z	CERAMIC	0.010UF	Z
C147A			CK73FB1H105Z	CHIP C	1.0UF	Z
C148			CC45FSL1H470J	CERAMIC	47PF	J
C150			CE04CW1C101M	ELECTRO	100UF	16WV
C152			CE04CW1A470M	ELECTRO	47UF	10WV
C160A			CK73FB1H472K	CHIP C	4700PF	K
C160A			CK73FB1H472K	CHIP C	4700PF	K
C160A			CK73FB1H472K	CHIP C	4700PF	K
C161A			CK73FB1H102K	CHIP C	1000PF	K
C162A			CK73FB1H105Z	CHIP C	1.0UF	Z
C163A			CK73FB1E223K	CHIP C	0.022UF	K
C164A			CK73FB1H224Z	CHIP C	0.22UF	Z
C166			CE04CW0J221M	ELECTRO	220UF	6.3WV
C167A			CC73FSL1H200J	CHIP C	20PF	J
C168A			CC73FSL1H390J	CHIP C	39PF	J
C169A			CK73FB1H105Z	CHIP C	1.0UF	Z
C171			CE04CW0J101M	ELECTRO	100UF	6.3WV
C172A			CK73FB1H105Z	CHIP C	1.0UF	Z
C177A			CK73FB1H105Z	CHIP C	1.0UF	Z
C180A			CK73FB1H105Z	CHIP C	1.0UF	Z
C182A			CK73FB1H105Z	CHIP C	1.0UF	Z
C184			CE04CW1A471M	ELECTRO	470UF	10WV
C201A			CK73FB1H272K	CHIP C	2700PF	K
C202			CK45FB1H301J	CERAMIC	300PF	J
C203, 204			CE04CW1H4R7M	ELECTRO	4.7UF	50WV
C205A			CK73FB1E223K	CHIP C	0.022UF	K
C206			CE04CW0J221M	ELECTRO	220UF	6.3WV
C207A			CK73FB1H224Z	CHIP C	0.22UF	Z
C220			CE04CW1A470M	ELECTRO	47UF	10WV

L : Scandinavia K : USA P : Canada R : Mexico C : China I : Malaysia

Y : PX(Far East, Hawaii) T : Europe E : Europe V : China(Shanghai)

Y : AAFES(Europe) X : Australia Q : Russia H : Korea M : Other Areas

Δ indicates safety critical components.

DPC-193/392/393/395/692/792/793/993

PARTS LIST

* New Parts

Parts without **Parts No.** are not supplied.
 Les articles non mentionnés dans le **Parts No.** ne sont pas fournis.
 Teile ohne **Parts No.** werden nicht geliefert.

5

Ref. No	Add-ress	New Parts	Parts No.	Description	Desti-nation	Re-marks
C221			CK45FB1H102K	CERAMIC 1000PF K	K6P6X6	
C221			CK45FB1H102K	CERAMIC 1000PF K	K9P9	
C221			CK45FB1H102K	CERAMIC 1000PF K	M1X1M2	
C221			CK45FB1H102K	CERAMIC 1000PF K	M4K5P5	
C221			CK45FB1H102K	CERAMIC 1000PF K	S3T3E3	
C221			CK45FB1H102K	CERAMIC 1000PF K	T2E2M3	
C301A			CK73FB1H272K	CHIP C 2700PF K		
C302			CK45FB1H301J	CERAMIC 300PF J		
C303, 304			CE04CW1H4R7M	ELECTRO 4.7UF 50WV		
C305A			CK73FB1E223K	CHIP C 0.022UF K		
C306			CE04CW0J221M	ELECTRO 220UF 6.3WV		
C307A			CK73FB1H224Z	CHIP C 0.22UF Z		
C320			CE04CW1A470M	ELECTRO 47UF 10WV		
C321			CK45FB1H102K	CERAMIC 1000PF K	K6P6X6	
C321			CK45FB1H102K	CERAMIC 1000PF K	K9P9	
C321			CK45FB1H102K	CERAMIC 1000PF K	M1X1M2	
C321			CK45FB1H102K	CERAMIC 1000PF K	M4K5P5	
C321			CK45FB1H102K	CERAMIC 1000PF K	S3T3E3	
C321			CK45FB1H102K	CERAMIC 1000PF K	T2E2M3	
C322			CE04KW1H4R7M	ELECTRO 4.7UF 50WV	E7	
C501			CE04CW1C220M	ELECTRO 22UF 16WV		
C502A			CK73FB1H105Z	CHIP C 1.0UF Z		
BT			E35-1995-08	2P J.WIRE(BLACK/GREY)		
BT1			E35-1994-08	2P J.WIRE(ORANGE/BLUE)		
CN4			E60-0005-08	FILM CONNECTOR, 15P		
J101	2B		E03-0356-08	DC JACK		
J102	2B		E11-0372-08	PHONE JACK 3.6MM GREEN		
J103	3B		E11-0355-08	STEREO PHONE JACK	S3E7M4	
J105	2B		E11-0354-08	LINE OUT(PHONE JACK)	K6P6X6	
J105	2B		E11-0354-08	LINE OUT(PHONE JACK)	K9P9	
J105	2B		E11-0354-08	LINE OUT(PHONE JACK)	M1X1M2	
J105	2B		E11-0354-08	LINE OUT(PHONE JACK)	M4K5P5	
J105	2B		E11-0354-08	LINE OUT(PHONE JACK)	S3E2M3	
L102			L33-0564-08	CHOKE COIL 33UH		
L105			L33-0564-08	CHOKE COIL 33UH		
L106			L33-0565-08	CHOKE COIL 95UH		
X1			L77-2240-08	CRYSTAL RESONATOR 16.9344MHZ		
JP15A			RK73FB2A000J	CHIP R 0 J 1/10W	S3	
JP173A			RK73FB2A000J	CHIP R 0 J 1/10W		
R1A-3A			RK73FB2A103J	CHIP R 10K J 1/10W		
R4A			RK73FB2A563J	CHIP R 56K J 1/10W	K9P9K6	
R4A			RK73FB2A563J	CHIP R 56K J 1/10W	M4	
R4A			RK73FB2A563J	CHIP R 56K J 1/10W	P6X6K5	
R5A			RK73FB2A153J	CHIP R 15K J 1/10W	K9P9K6	
R5A			RK73FB2A153J	CHIP R 15K J 1/10W	P6X6K5	
R7, 8			RK73FB2A473J	CHIP R 47K J 1/10W	E2X1	
R7, 8			RK73FB2A473J	CHIP R 47K J 1/10W	E7P5E3	
R7, 8			RK73FB2A473J	CHIP R 47K J 1/10W	T3M3S3	
R21A			RK73FB2A102J	CHIP R 1.0K J 1/10W		
R22A			RK73FB2A472J	CHIP R 4.7K J 1/10W		
R23A			RK73FB2A563J	CHIP R 56K J 1/10W		
R29A			RK73FB2A682J	CHIP R 6.8K J 1/10W		
R30A			RK73FB2A331J	CHIP R 330 J 1/10W		

L : Scandinavia K : USA P : Canada R : Mexico C : China I : Malaysia
 Y : PX(Far East, Hawaii) T : Europe E : Europe G : Germany V : China(Shanghai)
 Y : AAFES(Europe) X : Australia Q : Russia H : Korea M : Other Areas Δ indicates safety critical components.

* New Parts

Parts without **Parts No.** are not supplied.
 Les articles non mentionnés dans le **Parts No.** ne sont pas fournis.
 Teile ohne **Parts No.** werden nicht geliefert.

5

Ref. No	Add-ress	New Parts	Parts No.	Description	Desti-nation	Re-marks
R31A			RK73FB2A122J	CHIP R 1.2K J 1/10W		
R32A			RK73FB2A152J	CHIP R 1.5K J 1/10W		
R33A			RK73FB2A182J	CHIP R 1.8K J 1/10W		
R34A			RK73FB2A242J	CHIP R 2.4K J 1/10W		
R35A			RK73FB2A362J	CHIP R 3.6K J 1/10W		
R38A			RK73FB2A101J	CHIP R 100 J 1/10W	S3	
R38A			RK73FB2A331J	CHIP R 330 J 1/10W	E7M4	
R40A			RK73FB2A100J	CHIP R 10 J 1/10W		
R41A, 42A			RK73FB2A472J	CHIP R 4.7K J 1/10W		
R43A			RK73FB2A103J	CHIP R 10K J 1/10W		
R46A			RK73FB2A100J	CHIP R 10 J 1/10W		
R47A			RK73FB2A100J	CHIP R 10 J 1/10W		
R48A			RK73FB2A472J	CHIP R 4.7K J 1/10W	E7X6	
R49A			RK73FB2A100J	CHIP R 10 J 1/10W		
R51A			RK73FB2A122J	CHIP R 1.2K J 1/10W	E7M4	
R52A			RK73FB2A152J	CHIP R 1.5K J 1/10W	E7M4	
R54A			RK73FB2A223J	CHIP R 22K J 1/10W		
R55A			RK73FB2A103J	CHIP R 10K J 1/10W		
R56A			RK73FB2A223J	CHIP R 22K J 1/10W		
R57A			RK73FB2A224J	CHIP R 220K J 1/10W		
R58A			RK73FB2A103J	CHIP R 10K J 1/10W		
R59A			RK73FB2A333J	CHIP R 33K J 1/10W		
R60A			RK73FB2A122J	CHIP R 1.2K J 1/10W		
R61A			RK73FB2A333J	CHIP R 33K J 1/10W		
R66A, 67A			RK73FB2A103J	CHIP R 10K J 1/10W		
R68A			RK73FB2A473J	CHIP R 47K J 1/10W	E7	
R69A			RK73FB2A104J	CHIP R 100K J 1/10W		
R74A			RK73FB2A682J	CHIP R 6.8K J 1/10W		
R75A			RK73FB2A103J	CHIP R 10K J 1/10W	S3	
R76A			RK73FB2A332J	CHIP R 3.3K J 1/10W	S3	
R95A			RK73FB2A103J	CHIP R 10K J 1/10W	E2M1X1	
R95A			RK73FB2A103J	CHIP R 10K J 1/10W	T3M3S3	
R95A			RK73FB2A103J	CHIP R 10K J 1/10W	X6P5E3	
R97A			RK73FB2A222J	CHIP R 2.2K J 1/10W	E2M1X1	
R97A			RK73FB2A222J	CHIP R 2.2K J 1/10W	T3M3S3	
R97A			RK73FB2A222J	CHIP R 2.2K J 1/10W	X6P5E3	
R109A			RK73FB2A124J	CHIP R 120K J 1/10W		
R110A			RK73FB2A333J	CHIP R 33K J 1/10W		
R111A			RK73FB2A104J	CHIP R 100K J 1/10W	E7X6K5	
R111A			RK73FB2A104J	CHIP R 100K J 1/10W	M2M1X1	
R111A			RK73FB2A104J	CHIP R 100K J 1/10W	M3S3E2	
R111A			RK73FB2A104J	CHIP R 100K J 1/10W	P5E3T3	
R111A			RK73FB2A473J	CHIP R 47K J 1/10W	K9P9K6	
R111A			RK73FB2A473J	CHIP R 47K J 1/10W	P6M4	
R112A			RK73FB2A104J	CHIP R 100K J 1/10W	K9P9K6	
R112A			RK73FB2A104J	CHIP R 100K J 1/10W		
R112A			RK73FB2A154J	CHIP R 150K J 1/10W	P6M4	
R112A			RK73FB2A154J	CHIP R 150K J 1/10W	E7X6K5	
R112A			RK73FB2A154J	CHIP R 150K J 1/10W	M2M1X1	
R112A			RK73FB2A154J	CHIP R 150K J 1/10W	M3S3E2	
R112A			RK73FB2A154J	CHIP R 150K J 1/10W	P5E3T3	
R113A			RK73FB2A472J	CHIP R 4.7K J 1/10W		
R114A			RK73FB2A682J	CHIP R 6.8K J 1/10W		
R115A			RK73FB2A332J	CHIP R 3.3K J 1/10W		
R116			RK73FB2A153J	CHIP R 15K J 1/10W	E7X6	
R119A			RK73FB2A470J	CHIP R 47 J 1/10W		

L : Scandinavia K : USA P : Canada R : Mexico C : China I : Malaysia
 Y : PX(Far East, Hawaii) T : Europe E : Europe G : Germany V : China(Shanghai)
 Y : AAFES(Europe) X : Australia Q : Russia H : Korea M : Other Areas Δ indicates safety critical components.

DPC-193/392/393/395/692/792/793/993
 PARTS LIST

PARTS LIST

* New Parts
 Parts without **Parts No.** are not supplied.
 Les articles non mentionnés dans le **Parts No.** ne sont pas fournis.
 Teile ohne **Parts No.** werden nicht geliefert.



Ref. No	Add-ress	New Parts	Parts No.	Description	Desti-nation	Re-marks	
R121A			RK73FB2A222J	CHIP R 2.2K	J	1/10W	
R122A			RK73FB2A223J	CHIP R 22K	J	1/10W	
R123A			RK73FB2A472J	CHIP R 4.7K	J	1/10W	
R124A			RK73FB2A223J	CHIP R 22K	J	1/10W	
R125A			RK73FB2A203J	CHIP R 20K	J	1/10W	
R134A			RK73FB2A101J	CHIP R 100	J	1/10W	
R136A			RK73FB2A4R7J	CHIP R 4.7	J	1/10W	
R137A			RK73FB2A152J	CHIP R 1.5K	J	1/10W	
R138A			RK73FB2A100J	CHIP R 10	J	1/10W	
R140A			RK73FB2A474J	CHIP R 470K	J	1/10W	
R166A			RK73FB2A102J	CHIP R 1.0K	J	1/10W	
R168A			RK73FB2A103J	CHIP R 10K	J	1/10W	E2M2X1
R168A			RK73FB2A103J	CHIP R 10K	J	1/10W	E3T3M3
R168A			RK73FB2A103J	CHIP R 10K	J	1/10W	E7X6P5
R168A			RK73FB2A103J	CHIP R 10K	J	1/10W	M1X1
R168A			RK73FB2A103J	CHIP R 10K	J	1/10W	S3E2M2
R168A			RK73FB2A472J	CHIP R 4.7K	J	1/10W	K6P6K5
R168A			RK73FB2A472J	CHIP R 4.7K	J	1/10W	M4
R169A			RK73FB2A123J	CHIP R 12K	J	1/10W	M2M1X1
R169A			RK73FB2A123J	CHIP R 12K	J	1/10W	M3S3E2
R169A			RK73FB2A123J	CHIP R 12K	J	1/10W	P5M4E3
R169A			RK73FB2A123J	CHIP R 12K	J	1/10W	P6X6K5
R169A			RK73FB2A123J	CHIP R 12K	J	1/10W	P9E7K6
R169A			RK73FB2A472J	CHIP R 4.7K	J	1/10W	K9
R170A			RK73FB2A222J	CHIP R 2.2K	J	1/10W	K9P9K6
R170A			RK73FB2A222J	CHIP R 2.2K	J	1/10W	M4M2M1
R170A			RK73FB2A222J	CHIP R 2.2K	J	1/10W	P6X6K5
R170A			RK73FB2A562J	CHIP R 5.6K	J	1/10W	E2M2X1
R170A			RK73FB2A562J	CHIP R 5.6K	J	1/10W	E7P5E3
R170A			RK73FB2A562J	CHIP R 5.6K	J	1/10W	T3M3S3
R171A			RK73FB2A473J	CHIP R 47K	J	1/10W	K9P9K6
R171A			RK73FB2A473J	CHIP R 47K	J	1/10W	P6M4
R171A			RK73FB2A683J	CHIP R 68K	J	1/10W	E7X6K5
R171A			RK73FB2A683J	CHIP R 68K	J	1/10W	M2M1X1
R171A			RK73FB2A683J	CHIP R 68K	J	1/10W	M3S3E2
R171A			RK73FB2A683J	CHIP R 68K	J	1/10W	P5E3T3
R172A			RK73FB2A153J	CHIP R 15K	J	1/10W	K5M4M2
R172A			RK73FB2A153J	CHIP R 15K	J	1/10W	K9P9P6
R172A			RK73FB2A153J	CHIP R 15K	J	1/10W	M1
R174A			RK73FB2A682J	CHIP R 6.8K	J	1/10W	
R175A			RK73FB2A122J	CHIP R 1.2K	J	1/10W	
R177A			RK73FB2A683J	CHIP R 68K	J	1/10W	
R178A			RK73FB2A184J	CHIP R 180K	J	1/10W	
R179A			RK73FB2A821J	CHIP R 820	J	1/10W	
R180A			RK73FB2A473J	CHIP R 47K	J	1/10W	
R182A			RK73FB2A471J	CHIP R 470	J	1/10W	E3E7M2
R182A			RK73FB2A471J	CHIP R 470	J	1/10W	M3S3T3
R182A			RK73FB2A471J	CHIP R 470	J	1/10W	P5K9K6
R182A			RK73FB2A471J	CHIP R 470	J	1/10W	P6X6
R182A			RK73FB2A471J	CHIP R 470	J	1/10W	T2E2K5
R183A			RK73FB2A470J	CHIP R 47	J	1/10W	
R184A			RK73FB2A473J	CHIP R 47K	J	1/10W	
R189A			RK73FB2A103J	CHIP R 10K	J	1/10W	
R201A			RK73FB2A102J	CHIP R 1.0K	J	1/10W	
R202A			RK73FB2A473J	CHIP R 47K	J	1/10W	

L : Scandinavia K : USA P : Canada R : Mexico C : China I : Malaysia
 Y : PX(Far East, Hawaii) T : Europe E : Europe G : Germany V : China(Shanghai)
 Y : AAFES(Europe) X : Australia Q : Russia H : Korea M : Other Areas Δ indicates safety critical components.

* New Parts
 Parts without **Parts No.** are not supplied.
 Les articles non mentionnés dans le **Parts No.** ne sont pas fournis.
 Teile ohne **Parts No.** werden nicht geliefert.



Ref. No	Add-ress	New Parts	Parts No.	Description	Desti-nation	Re-marks	
R203A			RK73FB2A104J	CHIP R 100K	J	1/10W	
R204A			RK73FB2A471J	CHIP R 470	J	1/10W	
R206A			RK73FB2A153J	CHIP R 15K	J	1/10W	
R207A			RK73FB2A564J	CHIP R 560K	J	1/10W	
R209A			RK73FB2A100J	CHIP R 10	J	1/10W	
R210A			RK73FB2A101J	CHIP R 100	J	1/10W	
R211A			RK73FB2A681J	CHIP R 680	J	1/10W	
R220A			RK73FB2A302J	CHIP R 3.0K	J	1/10W	
R221A			RK73FB2A471J	CHIP R 470	J	1/10W	K6P6X6
R221A			RK73FB2A471J	CHIP R 470	J	1/10W	K9P9
R221A			RK73FB2A471J	CHIP R 470	J	1/10W	M1X1M2
R221A			RK73FB2A471J	CHIP R 470	J	1/10W	M4K5P5
R221A			RK73FB2A471J	CHIP R 470	J	1/10W	S3T3E3
R221A			RK73FB2A471J	CHIP R 470	J	1/10W	T2E2M3
R222A			RK73FB2A472J	CHIP R 4.7K	J	1/10W	
R301A			RK73FB2A102J	CHIP R 1.0K	J	1/10W	
R302A			RK73FB2A473J	CHIP R 47K	J	1/10W	
R303A			RK73FB2A104J	CHIP R 100K	J	1/10W	
R304A			RK73FB2A471J	CHIP R 470	J	1/10W	
R306A			RK73FB2A153J	CHIP R 15K	J	1/10W	
R307A			RK73FB2A564J	CHIP R 560K	J	1/10W	
R309A			RK73FB2A100J	CHIP R 10	J	1/10W	
R310A			RK73FB2A101J	CHIP R 100	J	1/10W	
R311A			RK73FB2A681J	CHIP R 680	J	1/10W	
R320A			RK73FB2A302J	CHIP R 3.0K	J	1/10W	
R321A			RK73FB2A471J	CHIP R 470	J	1/10W	
R322A			RK73FB2A472J	CHIP R 4.7K	J	1/10W	
R501A			RK73FB2A333J	CHIP R 33K	J	1/10W	
R502A			RK73FB2A333J	CHIP R 33K	J	1/10W	
R504A			RK73FB2A184J	CHIP R 180K	J	1/10W	
R505A			RK73FB2A472J	CHIP R 4.7K	J	1/10W	
VR101			R31-0086-08	VARIABLE RESISTOR			
SW101~103		*	S70-0066-08	TACT SWITCH			
SW104		*	S70-0062-08	TACT SWITCH			
SW105		*	S70-0066-08	TACT SWITCH			
SW106		*	S70-0062-08	TACT SWITCH			
SW107		*	S62-0081-08	SLIDE SWITCH			
SW108		*	S62-0064-08	SWITCH			E2
SW108		*	S62-0064-08	SWITCH			S3M4T2
SW108		*	S62-0064-08	SWITCH			T3E3M3
SW108		*	S62-0084-08	SWITCH			E7K5P5
SW108		*	S62-0084-08	SWITCH			K9P9K6
SW108		*	S62-0084-08	SWITCH			
SW109		*	S62-0084-08	SWITCH			P6X6M6
SW109		*	S74-0084-08	MICRO SWITCH			
D104			SB10-03A3-BT	DIODE			
D105			GMB01-BT	DIODE			
D111, 112			IN-4001	DIODE			
D115, 116			GMB01-BT	DIODE			
D117			GMB01-BT	DIODE			S3E7M4
D118			1SS355	DIODE			
D122A			1SS355	DIODE			S3E7M4
D201			GMB01-BT	DIODE			
D301			GMB01-BT	DIODE			
IC1		*	AN8838SB	IC(CD DIGITAL SERVO)			

L : Scandinavia K : USA P : Canada R : Mexico C : China I : Malaysia
 Y : PX(Far East, Hawaii) T : Europe E : Europe G : Germany V : China(Shanghai)
 Y : AAFES(Europe) X : Australia Q : Russia H : Korea M : Other Areas Δ indicates safety critical components.

* New Parts

Parts without **Parts No.** are not supplied.

Les articles non mentionnés dans le **Parts No.** ne sont pas fournis.

Teile ohne **Parts No.** werden nicht geliefert.

9

Ref. No	Add-ress	New Parts	Parts No.	Description	Desti-nation	Re-marks
IC2		*	AN8789FB	IC		
IC3		*	MN101C167	IC		
IC4		*	MN662746RPK1	IC		
IC5			SM5859AF	IC		
IC6			MN41V17400CTT6	IC	E7K5P5	
IC6			MN41V17400CTT6	IC	K9P9K6	
IC6			MN41V17400CTT6	IC	P6X6	
IC7			MN41V4400SJ-08	IC	M2E2M3	
IC7			MN41V4400SJ-08	IC	S3T3E3	
IC7			MN41V4400SJ-08	IC	M4	
IC8			MN41V4400SJ-09	IC	M2E2M4	
IC9			NUM2073M	IC(AF POWER AMP)		
Q4			2SC3330	TRANSISTOR		
Q5			2SA1317	TRANSISTOR		
Q6			2SC3330	TRANSISTOR		
Q102			2SB598F	TRANSISTOR		
Q104			2SA1317	TRANSISTOR		
Q105			2SC4048-AC	TRANSISTOR		
Q106			2SC4481T	TRANSISTOR		
Q107			2SD734F	TRANSISTOR		
Q108			2SD1805F	TRANSISTOR		
Q108			2SD1805G	TRANSISTOR		
Q110			2SA1317	TRANSISTOR		
Q111, 112			2SB926T	TRANSISTOR		
Q113			2SA1317	TRANSISTOR	S3	
Q115			2SC4048-AC	TRANSISTOR		
Q116		*	2SA1564-AC	TRANSISTOR		
Q201			2SC3330	TRANSISTOR		
Q202			2SD734F	TRANSISTOR		
Q203			2SC3860	TRANSISTOR	K6P6X6	
Q203			2SC3860	TRANSISTOR	K9P9	
Q203			2SC3860	TRANSISTOR	M1X1M2	
Q203			2SC3860	TRANSISTOR	M4K5P5	
Q203			2SC3860	TRANSISTOR	S3T3E3	
Q203			2SC3860	TRANSISTOR	T2E2M3	
Q205			2SC3860	TRANSISTOR		
Q301			2SC3330	TRANSISTOR		
Q302			2SD734F	TRANSISTOR		
Q303			2SC3860	TRANSISTOR	K6P6X6	
Q303			2SC3860	TRANSISTOR	K9P9	
Q303			2SC3860	TRANSISTOR	M1X1M2	
Q303			2SC3860	TRANSISTOR	M4K5P5	
Q303			2SC3860	TRANSISTOR	S3T3E3	
Q303			2SC3860	TRANSISTOR	T2E2M3	
Q304			2SC3330	TRANSISTOR	E7	
Q305			2SC3860	TRANSISTOR		
J104			W02-2630-08	OPTICAL OUT 3.6MM GREEN	E7	

L : Scandinavia K : USA P : Canada R : Mexico C : China I : Malaysia
 Y : PX(Far East, Hawaii) T : Europe E : Europe G : Germany V : China(Shanghai)
 Y : AAFES(Europe) X : Australia Q : Russia H : Korea M : Other Areas Δ indicates safety critical components.

HOW TO READ THE PARTS LIST

ABBREVIATION OF MODEL AND MASS PRODUCTION'S DESTINATIONS

MODEL	ABB.	Australia	Canada	China	England	Europe	Germany	Korea	Malaysia
DPC-193	-	X1	-	-	-	-	-	-	-
DPC-392	-	-	-	-	-	E2	-	-	-
DPC-393	-	-	-	-	T3	E3	-	-	-
DPC-395	-	-	-	-	-	-	-	-	-
DPC-692	-	-	P5	-	-	-	-	-	-
DPC-792	-	X6	P6	-	-	-	-	-	-
DPC-793	-	-	-	-	-	E7	-	-	-
DPC-795	-	-	-	-	-	-	-	-	-
DPC-993	-	-	P9	-	-	-	-	-	-

MODEL	ABB.	Mexico	PX/AAFES	Russia	Scandinavia	Shanghai	USA	Other area	Other area(M2)
DPC-193	-	-	-	-	-	-	-	M1	-
DPC-392	-	-	-	-	-	-	-	M2	-
DPC-393	-	-	-	-	-	-	-	M3	S3
DPC-395	-	-	-	-	-	-	-	M4	-
DPC-692	-	-	-	-	-	-	K5	-	-
DPC-792	-	-	-	-	-	-	K6	-	-
DPC-793	-	-	-	-	-	-	-	-	-
DPC-795	-	-	-	-	-	-	-	-	-
DPC-993	-	-	-	-	-	-	K9	-	-

PARTS LIST

DPC-193/392/393/395/692/792/793/993

Note:

Component and circuit are subject to modification to insure best operation under differing local conditions. This manual is based on Europe (E) standard, and provides information on regional circuit modification through use of alternate schematic diagrams, and information on regional component variations through use of parts list.

KENWOOD CORPORATION

14-6, Dogenzaka 1-chome, Shibuya-ku, Tokyo, 150-8501 Japan

KENWOOD SERVICE CORPORATION

P.O. BOX 22745, 2201 East Dominguez St., Long Beach, CA 90801-5745, U.S.A.

KENWOOD ELECTRONICS CANADA INC.

6070 Kestrel Road, Mississauga, Ontario, Canada L5T 1S8

KENWOOD ELECTRONICS LATIN AMERICA S.A.

P.O. BOX 55-2791, Piso 6 plaza Chase, Cl. 47 y Aquilino de la Guardia Panama, Republic de Panama

KENWOOD ELECTRONICS BRASIL LTDA.

Av Indianópolis, 628, 04062-001 Planalto Paullista São Paulo-SP-Brasil

KENWOOD ELECTRONICS U.K. LIMITED

KENWOOD House, Dwight Road, Watford, Herts., WD1 8EB., United Kingdom

KENWOOD ELECTRONICS BELGUM N.V.

Meachelsesteenweg 418, B-1930 Zaventem, Belgium

KENWOOD ELECTRONICS DEUTSCHLAND GMBH

Rembrücker Str. 15, 63150 Heusenstamm, Germany

KENWOOD ELECTRONICS FRANCE S.A.

13 Boulevard Ney, 75018 Paris, France

KENWOOD ELECTRONICS ITALIA S.p.A.

Via G. Sirtori, 7/9 20129, Milano, Italy

KENWOOD IBÉRICA S.A.

Bolivia, 239-08020 Barcelona, Spain

KENWOOD ELECTRONICS AUSTRALIA PTY. LTD.

(A.C.N. 001499 074)

P.O. Box 504, 8 Figtree Drive, Australia Centre, Homebush, N.S.W. 2140, Australia

KENWOOD & LEE ELECTRONICS, LTD.

Unit 3712-3724, Level 37, Tower 1, Metroplaza, 223 Hing Fong Road, Kwai Fong N.T., Hong Kong

KENWOOD ELECTRONICS GULF FZE

P.O. Box 61318, Jebel Ali, Dubai, U.A.E.

KENWOOD ELECTRONICS SINGAPORE PTE LTD.

No. 1 Genting Lane #02-02, KENWOOD Building, Singapore, 349544

KENWOOD ELECTRONICS (MALAYSIA) SDN BHD.

#4.01 Level 4, Wisma Academy Lot 4A, Jalan 19/1 46300 Petaling Jaya Selangor Darul Ehsan Malaysia

KENWOOD ELECTRONICS (THAILAND) CO., LTD.

573/111 Soi Ramkhamhaeng 39, Ramkhamhaeng Road, Wangthonglang, Bangkok, Bangkok 10301 Thailand